



LANDMARK

Lumber Group

MOULDING PROFILES



From Astragals to Wainscot Caps, Landmark Lumber has an extensive selection of Moulding Profile Knives on hand to meet your every need. We also Grind Custom Knives in-house to exactly match your drawing or sample. This guide provides details on the most popular profiles available.

Our millwork services are intended for qualified wholesale contacts only. However our minimum order size is 500 lineal feet, ideal for single-family home projects. We can run orders of any size as a single project order or use our Millwork to supplement your moulding production operations. At Landmark Lumber, we're ready to serve your moulding needs.

Contact one of our Lumber Consultants to discuss your project needs.

Phone: (717) 664-7373

Email: sales@landmarklumber.US



INDEX

ASTRAGAL	PAGE 4
BALUSTER	PAGE 4
BASE BASE	PAGE 5-12
CAP BASE	PAGE 13-15
SHOE	PAGE 16
BATTEN	PAGE 17
CASING	PAGE 18-21
CHAIR RAIL	PAGE 22-24
CORNER, QUARTER	PAGE 25
CROWN	PAGE 26-31
DOOR JAMB	PAGE 32
DOOR STILE	PAGE 33
DOOR STOP	PAGE 33
DRAWERSIDE	PAGE 34
FLOORING HALF ROUND	PAGE 35
HANDRAIL	PAGE 36-37
LANDING TREAD	PAGE 38
NOSING	PAGE 39-40
PANELLING	PAGE 41-43
PLATE STOCK	PAGE 43
WAINSCOT CAP	PAGE 44



ASTRAGALS

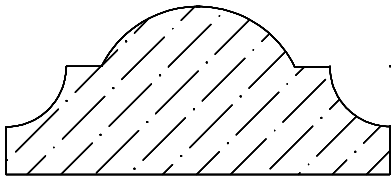

MP1-01
7/8 x 2

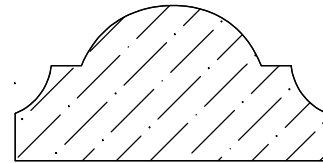

MP1-02
13/16 x 1 5/8



MP1-03
9/16 x 1-1/2



MP1-04
3/8 x 7/8

BALUSTER

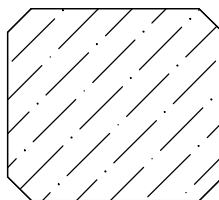

MP26-02
1-1/16 x 1-1/16



BASE

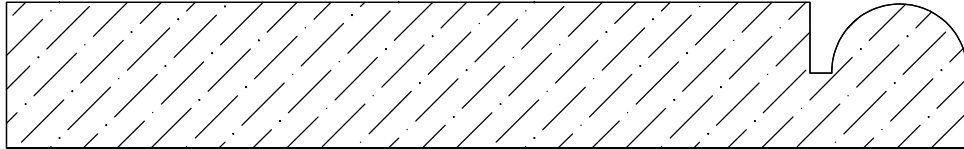

MP2-02 3/4 x 5

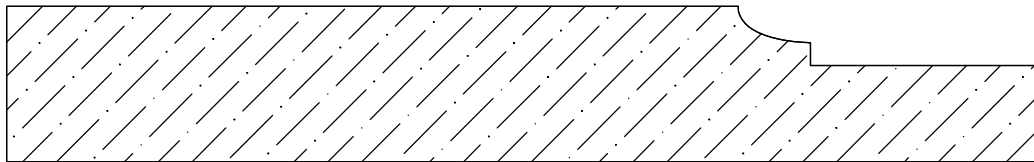

MP2-03 13/16 x 5-3/8

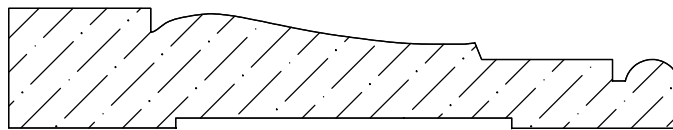

MP2-04 5/8 x 3-1/2

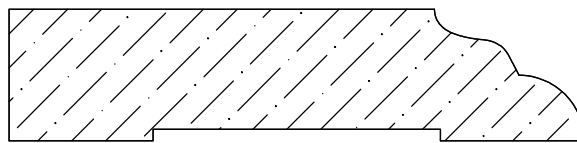

MP2-05 5/8 x 3

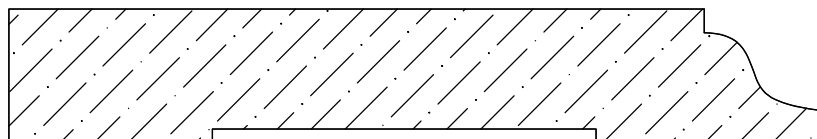

MP2-06 11/16 x 4-1/4



BASE (cont.)

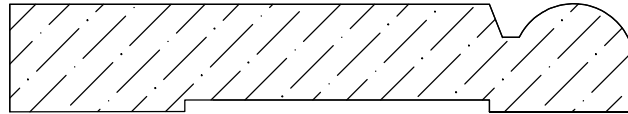

MP2-07 9/16 x 3-1/4

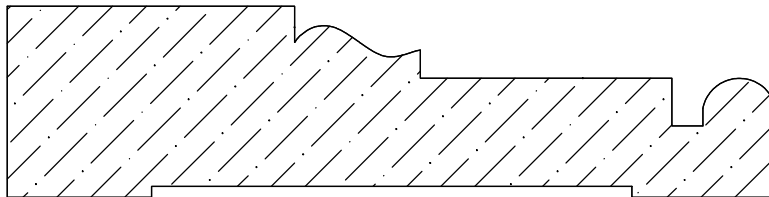

MP2-09 1 x 4

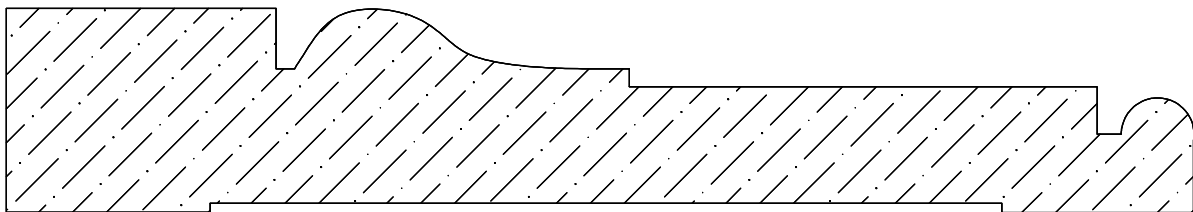

MP2-10 1-1/16 x 6-3/16

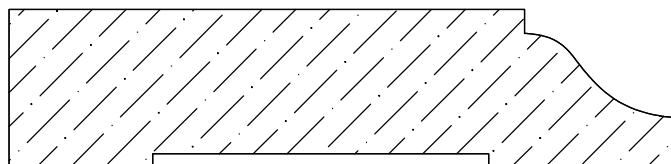

MP2-11 13/16 x 3-1/2

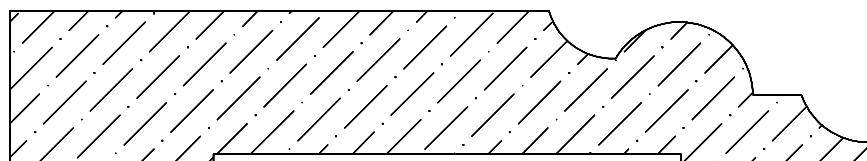

MP2-12 13/16 x 4-1/2



BASE (cont.)

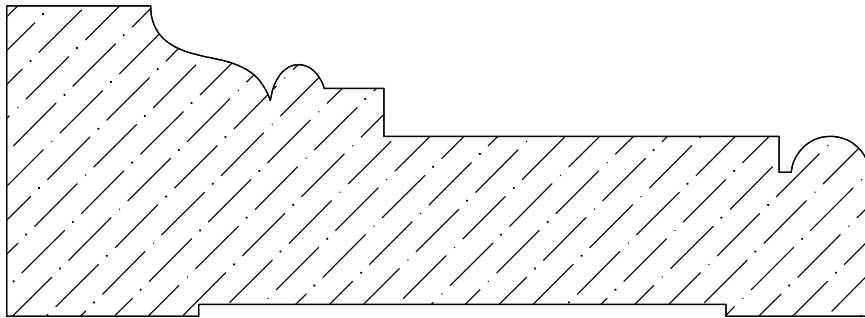

MP2-14 1-5/8 x 4-1/2

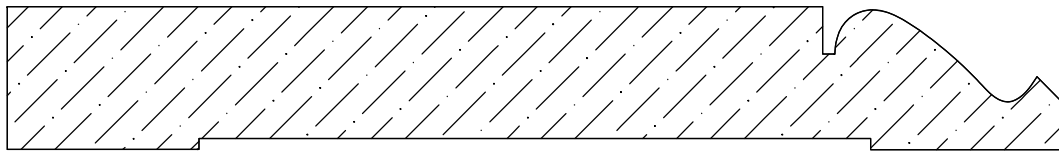

MP2-16 3/4 x 5-1/2

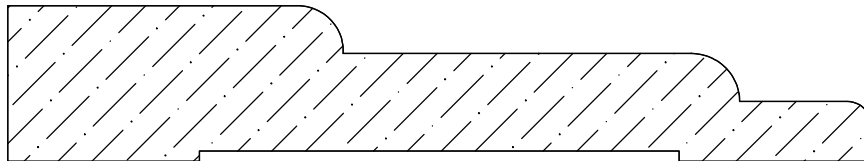

MP 2-18 13/16 x 4-1/2

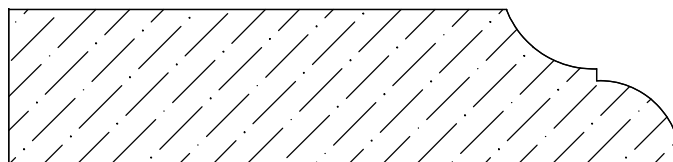

MP2-19 13/16 x 3-1/2

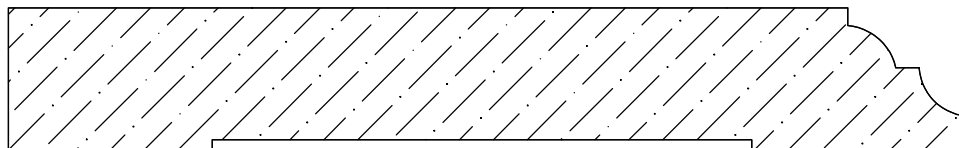

MP2-20 3/4 x 5



BASE (cont.)

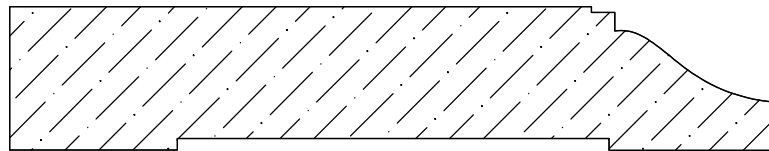

MP2-21 3/4 x 4

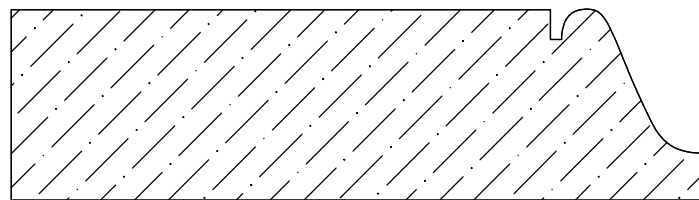

MP2-22 1 x 3-5/8

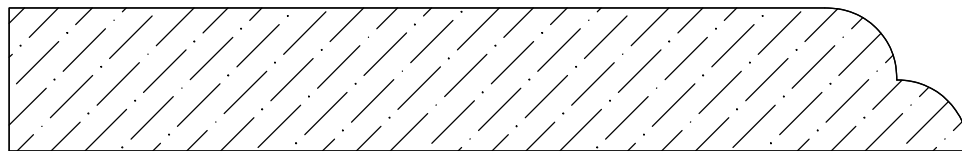

MP2-24 3/4 x 5

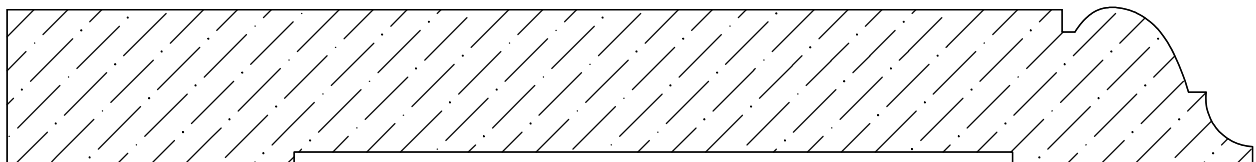

MP2-28 13/16 x 6-1/2

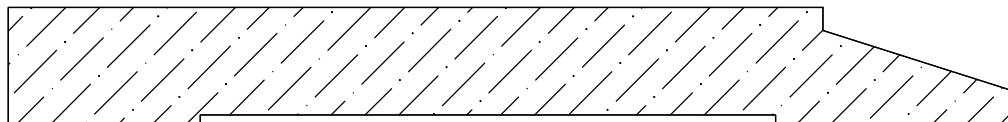

MP2-29 5/8 x 5-1/4



BASE (cont.)

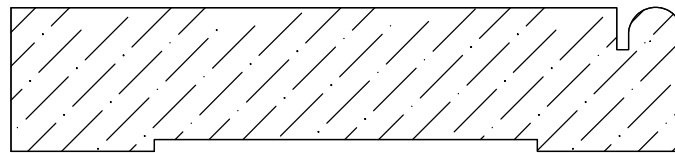

MP2-31 3/4 x 3-1/2

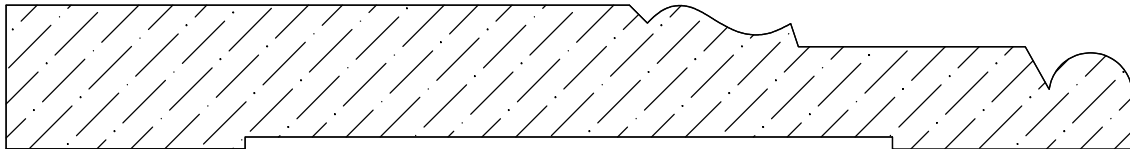

MP2-32 3/4 x 5-7/8

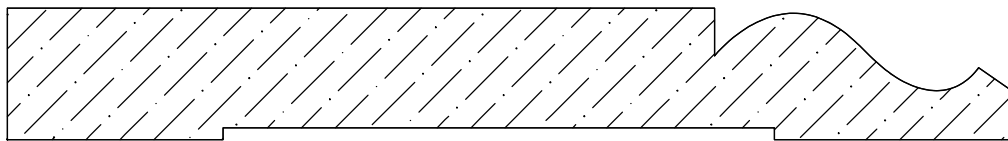

MP2-33 11/16 x 5-1/4

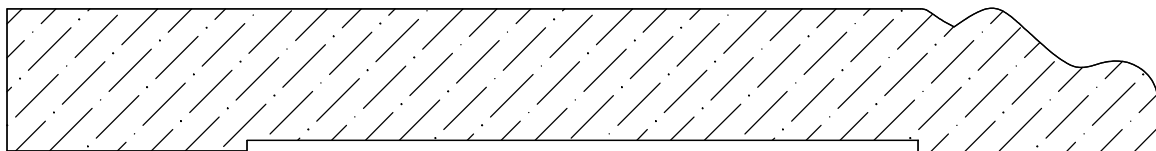

MP2-35 3/4 x 6

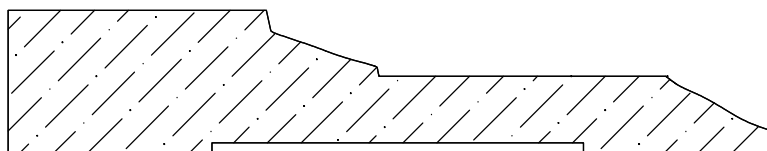

MP2-36 3/4 x 4



BASE (cont.)

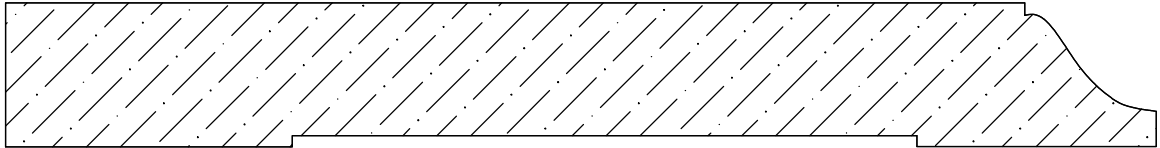

MP2-38 3/4 x 6

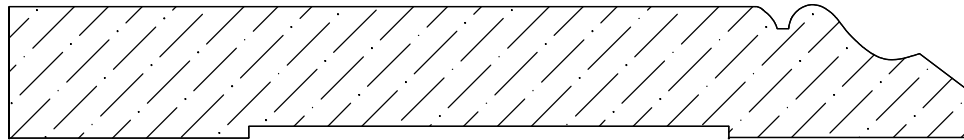

MP2-39 11/16 x 5

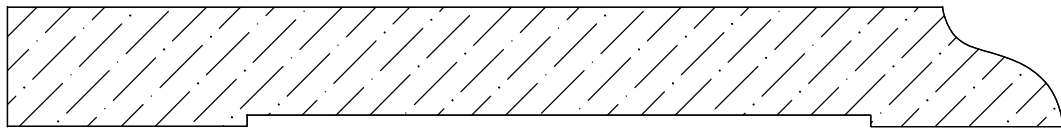

MP2-41 5/8 x 5-1/2

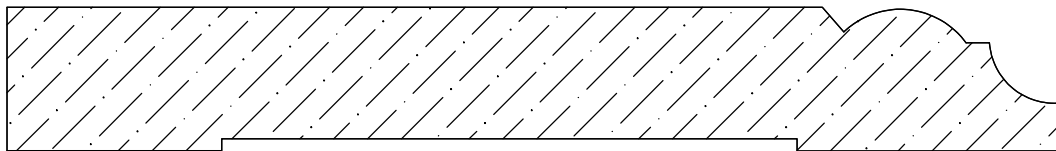

MP2-42 3/4 x 5-1/2

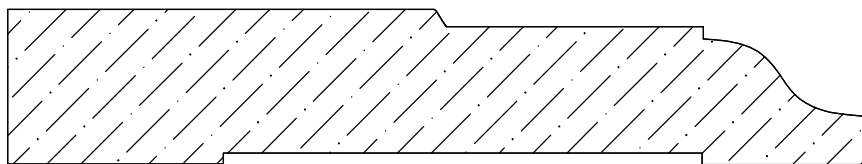

MP2-43 13/16 x 4-1/2



BASE (cont.)

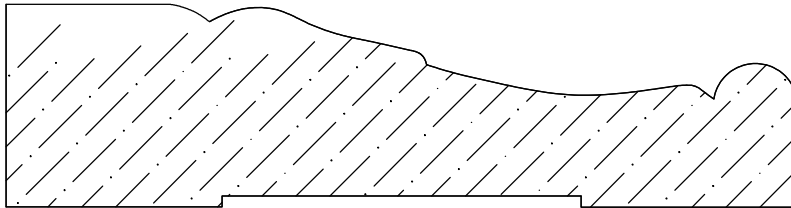

MP2-46 1-1/16 x 4-1/8

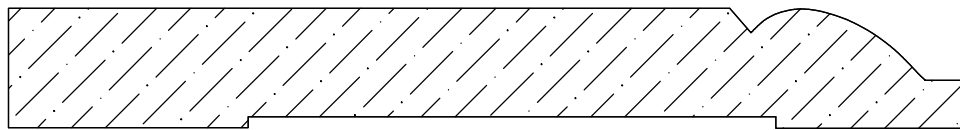

MP2-47 5/8 x 5

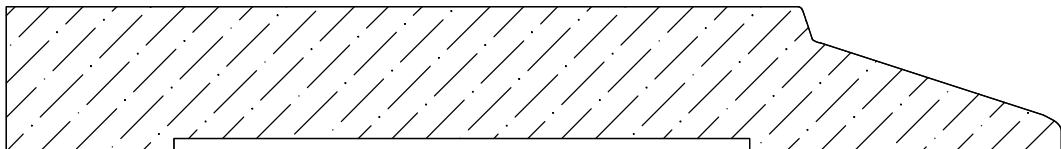

MP2-53 3/4 x 5-1/2

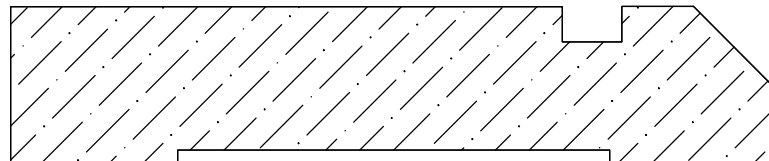

MP2-54 13/16 x 4

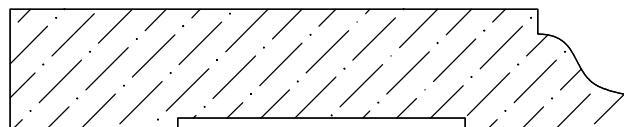

MP2-56 5/8 x 3-1/4



BASE (cont.)

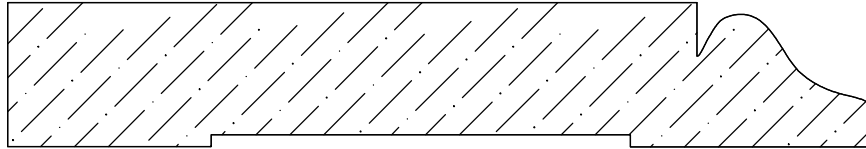

MP2-57 3/4 x 4-1/2

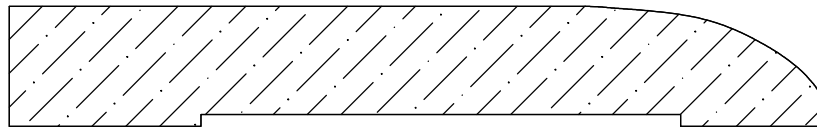

MP2-58 5/8 x 4-1/4



BASE CAP

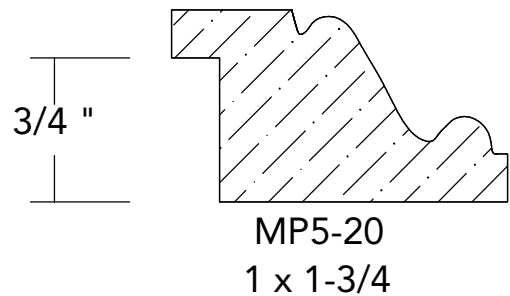
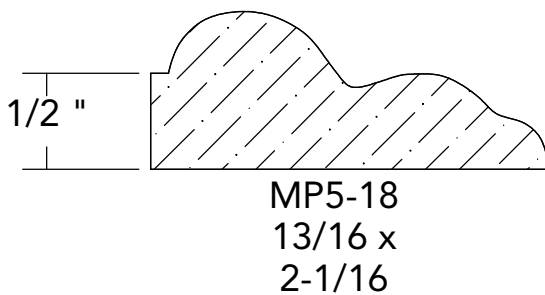
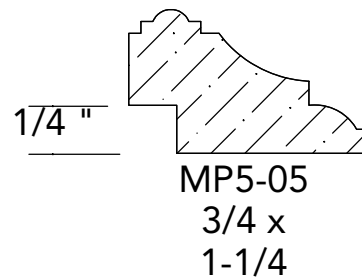
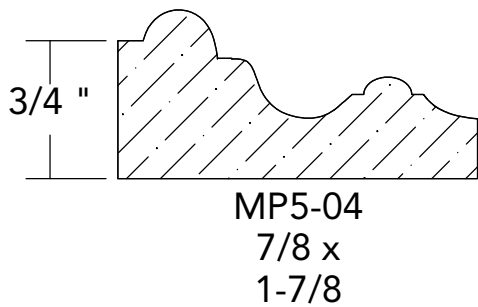
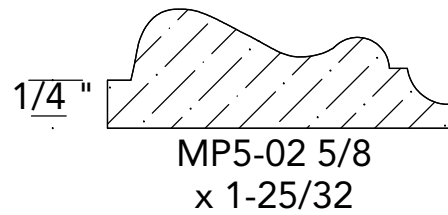
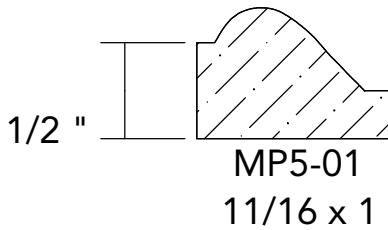



BASE CAP (cont.)

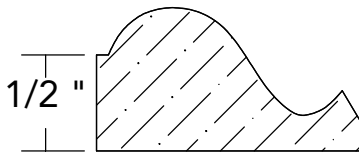

MP5-06
3/4 x 1-3/8

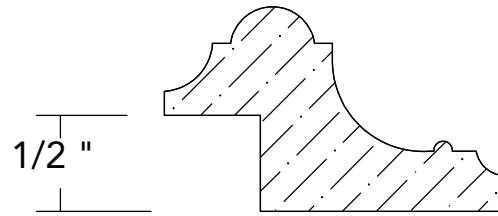

MP5-07
1-1/16 x 1-3/4

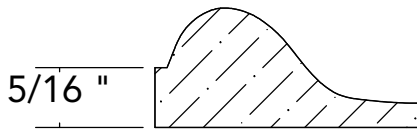

MP5-08
5/8 x 1-3/8

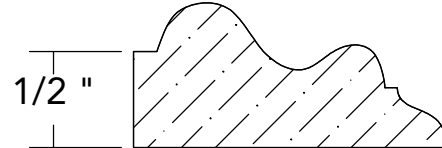

MP5-09
3/4 x 1-5/8

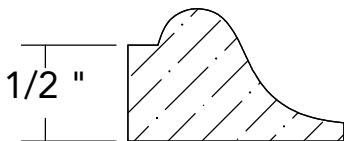

MP5-10
11/16 x 1-1/8

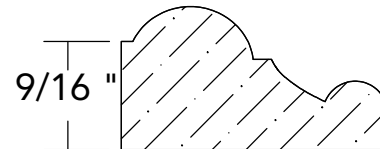

MP5-11
3/4 x 1-3/8



BASE CAP (cont.)

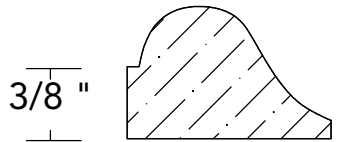

MP5-12
11/16 x 1-1/16

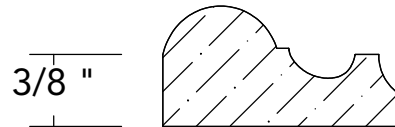

MP5-13
5/8 x 1-1/4

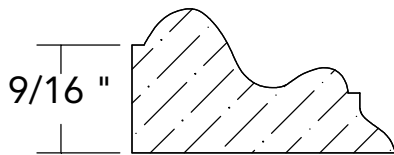

MP5-14
3/4 x 1-3/8

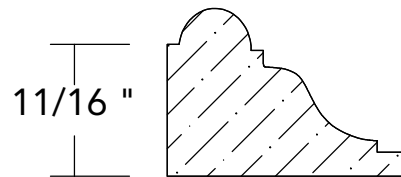

MP5-15
7/8 x 1-1/4

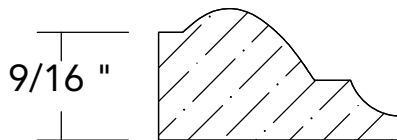

MP5-16
11/16 x 1-1/4



MP5-17
11/16 x 1-1/2



BASE SHOE

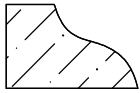

MP3-02
7/16 x 11/16

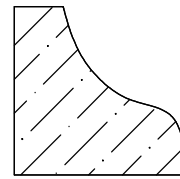

MP3-03
7/8 x 7/8



BATTEN



MP4-01
5/16 x 1-7/16

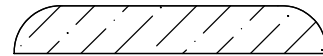

MP4-02
1/4 x 1-5/8

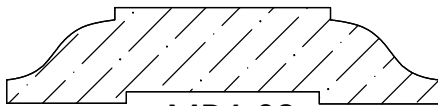

MP4-03
9/16 x 2-1/4

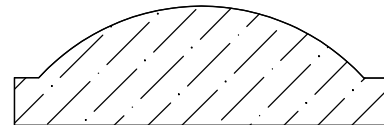

MP4-04
5/8 x 1-15/16

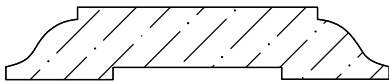

MP4-05
3/8 x 2

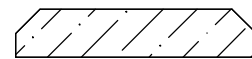

MP4-06
1/4 x 1-1/4

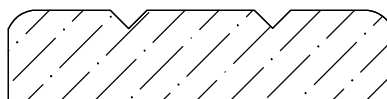

MP4-07
1/2 x 2



CASING

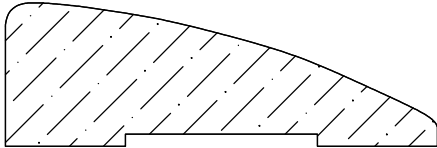

MP7-01
3/4 x 2-1/4

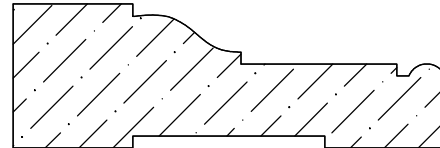

MP7-02
3/4 x 2-1/4

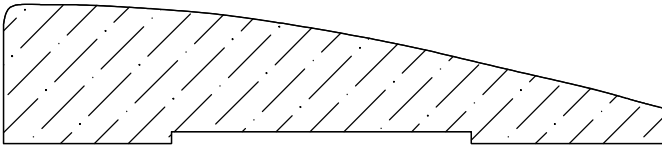

MP7-04
23/32 x 3-5/16

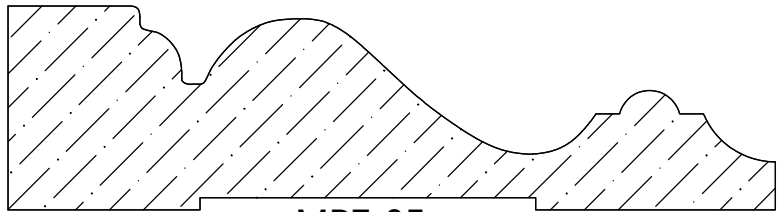

MP7-05
1-1/16 x 4-1/8

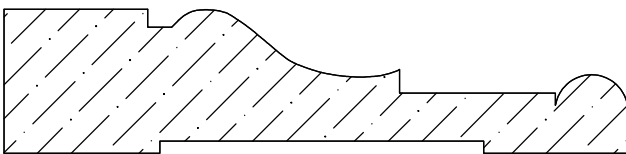

MP7-06
3/4 x 3-1/4

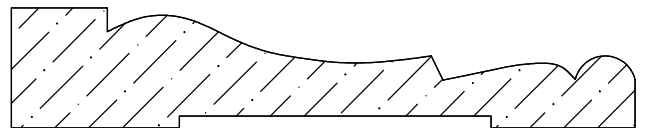

MP7-07
5/8 x 3-1/4

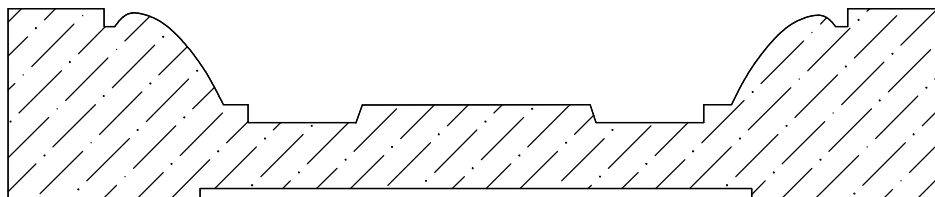

MP7-08
1 x 4-7/8



CASING (cont.)

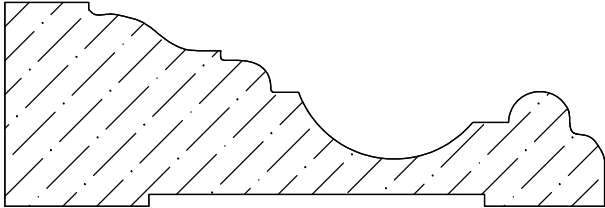

MP7-09
1-1/16 x 3-1/8



MP7-11
11/16 x 3-1/2

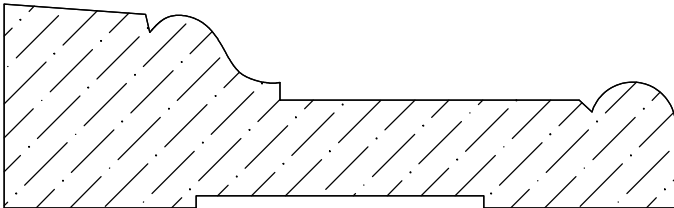

MP7-12
1-1/16 x 3-1/2

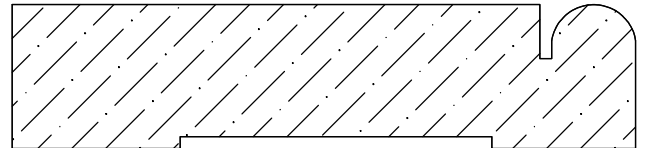

MP7-13
3/4 x 3-1/4

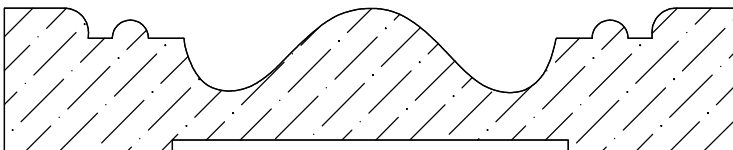

MP7-14
3/4 x 3-13/16

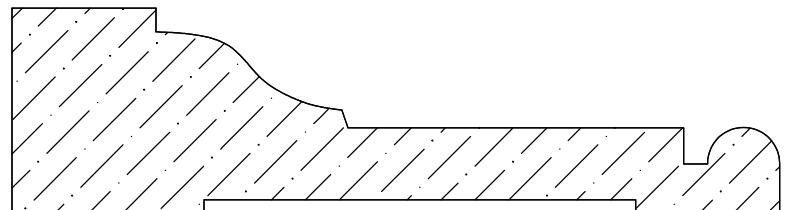

MP7-15
1-1/16 x 4

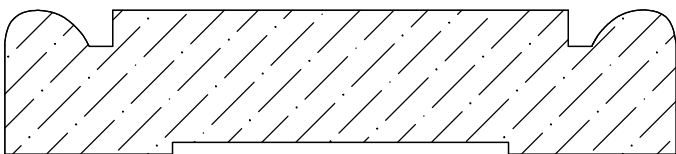

MP7-16
3/4 x 3-1/2

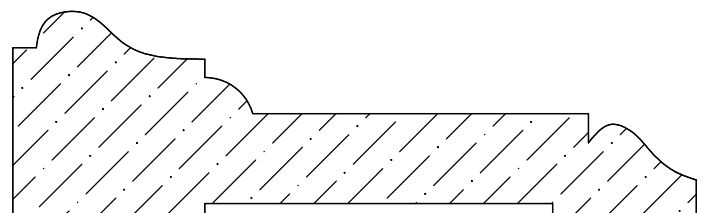

MP7-17
1-1/16 x 3-9/16



CASING (cont.)

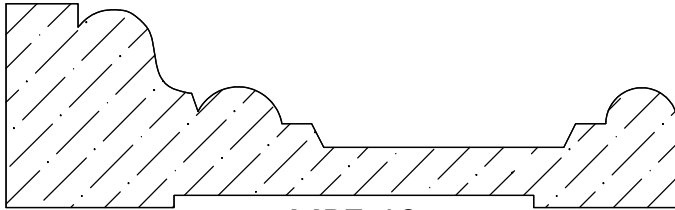

MP7-18
1-1/16 x 3-1/2

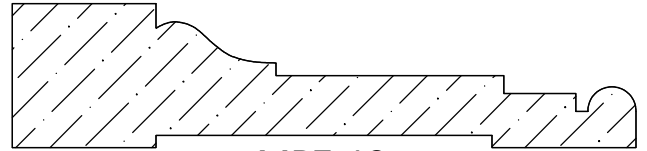

MP7-19
3/4 x 3-1/4



MP7-20
13/16 x 4-5/16

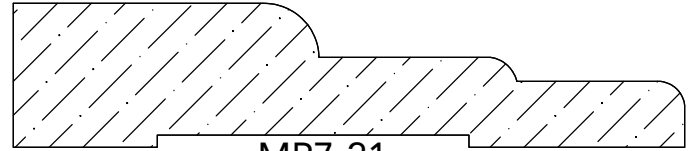

MP7-21
3/4 x 3-1/2

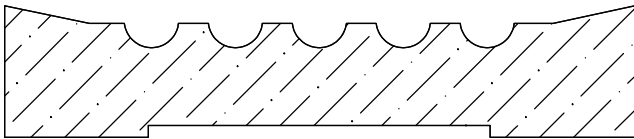

MP7-22
11/16 x 3-9/32

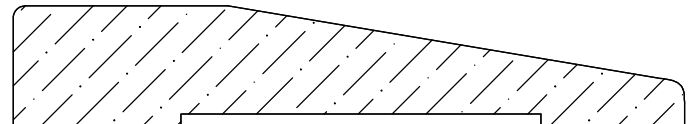

MP7-23
5/8 x 3-1/2

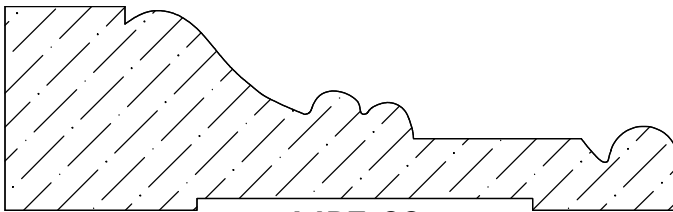

MP7-29
1-1/16 x 3-1/2

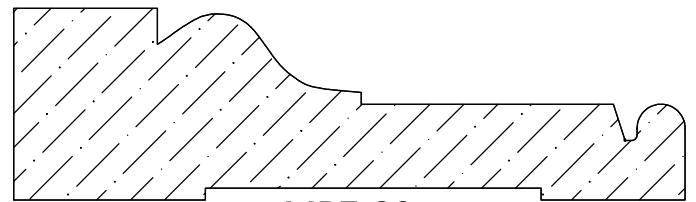

MP7-30
1 x 3-1/2



CASING (cont.)

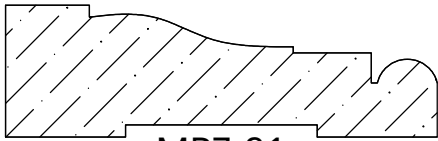

MP7-31
11/16 x 2-1/4

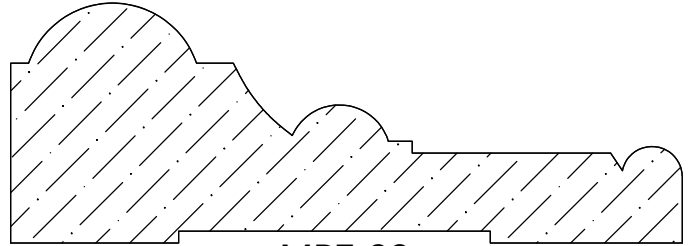

MP7-32
1-1/4 x 3-1/2

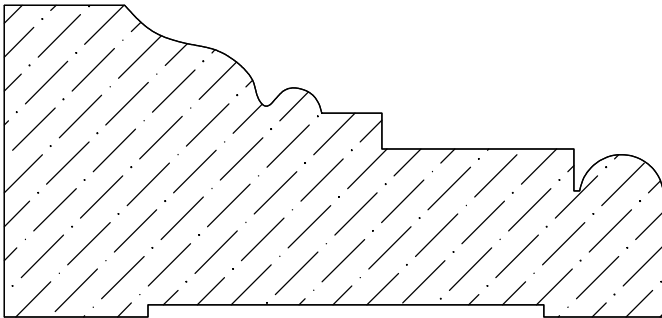

MP7-33
1-5/8 x 3-7/16



MP7-34
13/16 x 3-9/16

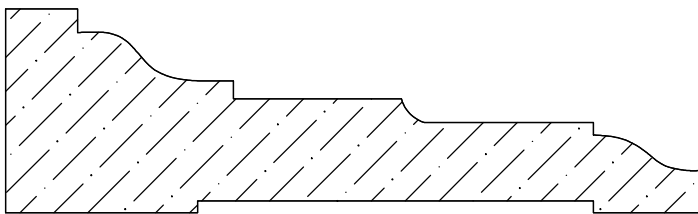

MP7-35
1-1/16 x 3-5/8

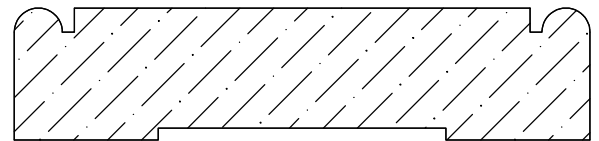

MP7-36
11/16 x 3

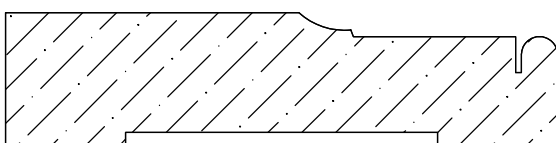

MP7-37
11/16 x 2-7/8

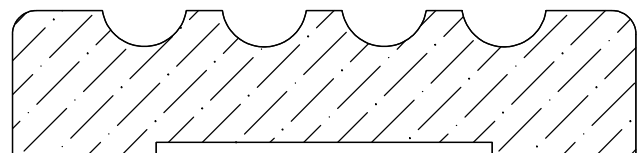

MP7-38
3/4 x 3-1/4



CHAIR RAIL

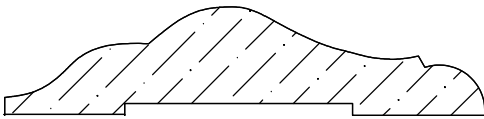

MP8-03
9/16 x 2-1/2

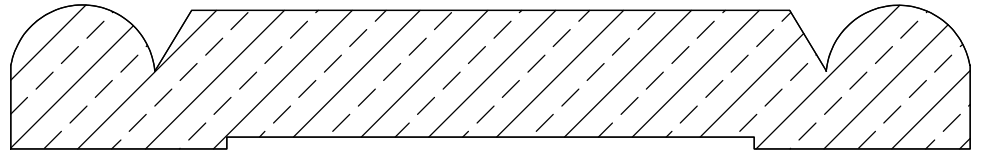

MP8-02
3/4 x 5

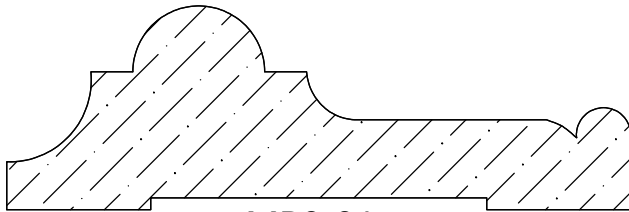

MP8-01
1-1/16 x 3-1/4

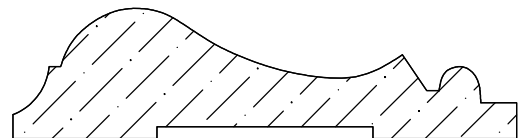

MP8-04
11/16 x 2-5/8

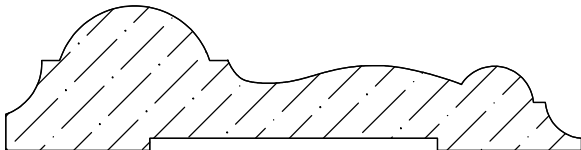

MP8-05
3/4 x 3

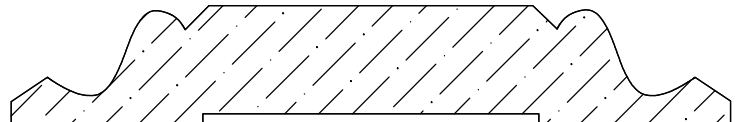

MP8-06
5/8 x 3-3/4

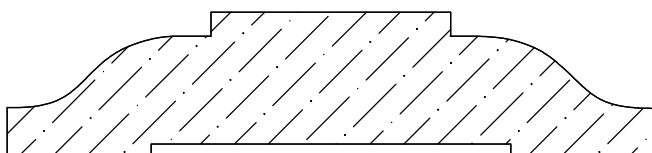

MP8-07
3/4 x 3-3/8

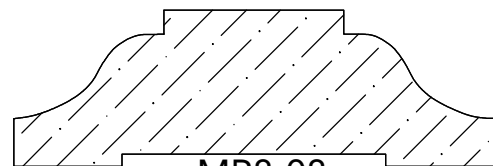

MP8-08
13/16 x 2-1/2



CHAIR RAIL (cont.)

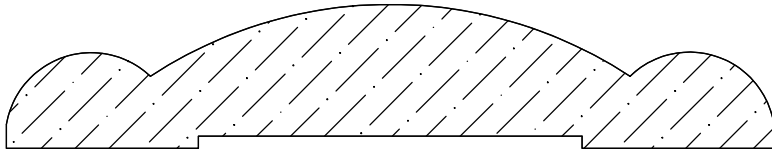

MP8-10
3/4 X 4

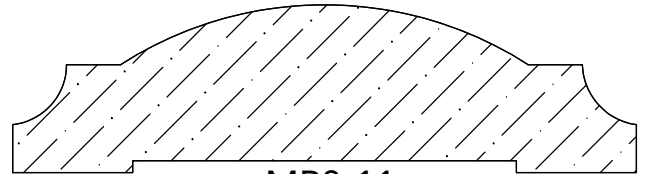

MP8-11
7/8 x 3-1/4



MP8-12
1/2 x 3

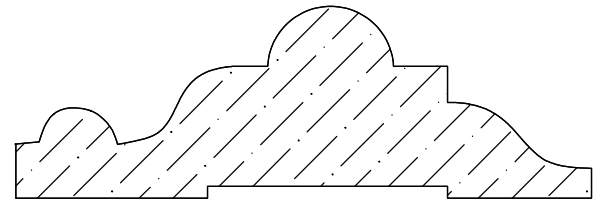

MP8-13
1 x 3

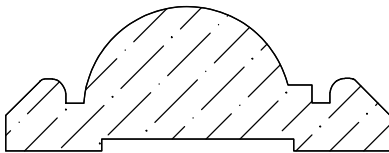

MP8-14
3/4 x 2

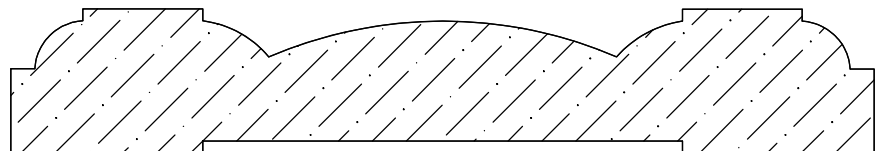

MP8-15
3/4 x 4-1/2

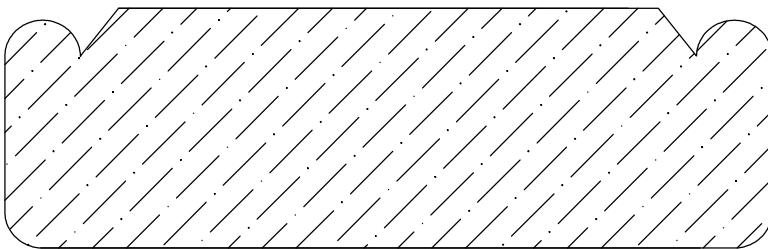

MP8-16
1-1/4 x 4

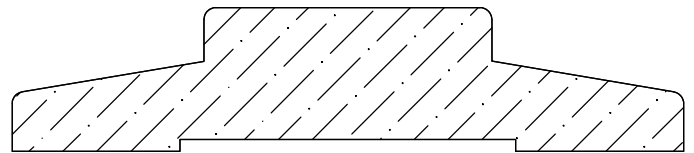

MP8-17
3/4 x 3-1/2



CHAIR RAIL (cont.)

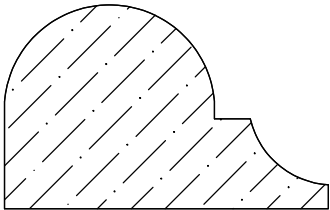

MP8-18
1-1/16 x 1-11/16

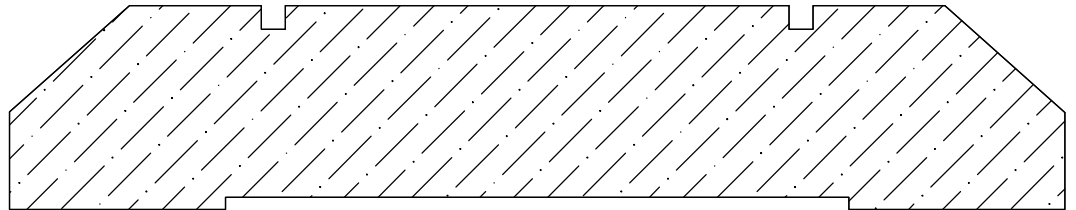

MP8-19
1-1/16 x 5-1/2

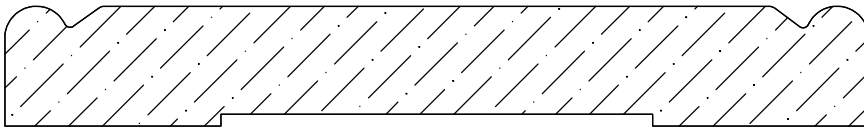

MP8-22
5/8 x 4-1/2

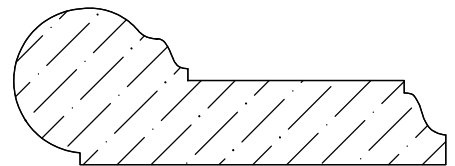

MP8-28
13/16 x 2-1/4

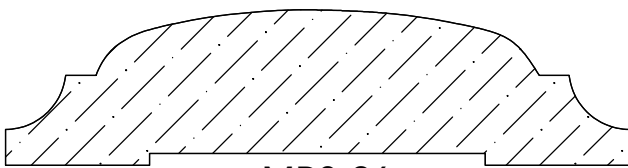

MP8-26
13/16 x 3-1/4

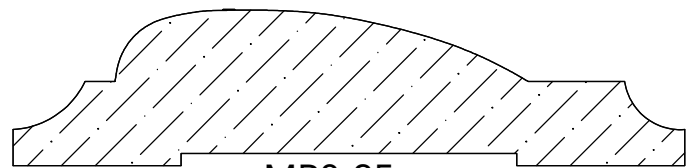

MP8-25
13/16 x 3-1/2



MP8-29
5/8 x 1-1/4

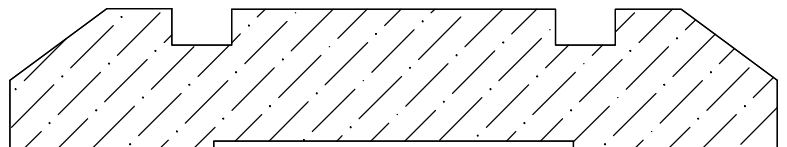

MP8-35
3/4 x 4



CORNER

Inside

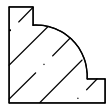

MP10-01
1/2 x 1/2



MP10-02
7/16 x 7/16

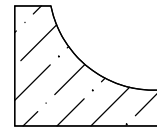

MP10-04
5/8 x 3/4

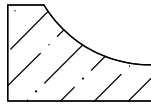

MP10-08
1/2 x 3/4

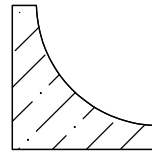

MP10-05
3/4 x 3/4

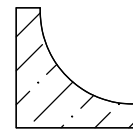

MP 10-6
5/8 x 5/8



MP10-09
3/8 x 1/2

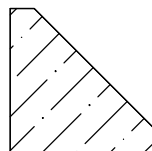

MP10-07
3/4 x 3/4



CROWN

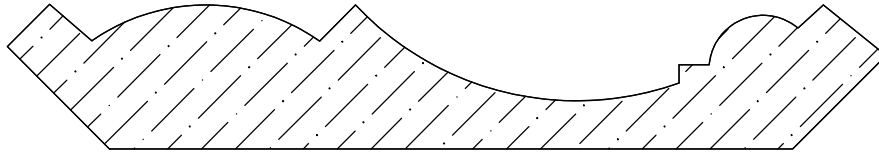

MP11-01 3/4 x 4-5/8

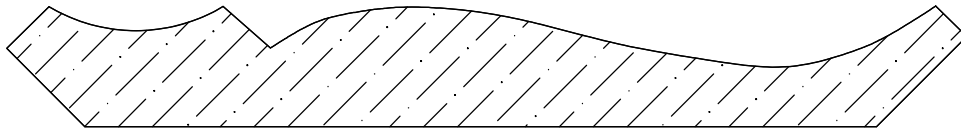

MP11-05 5/8 x 5

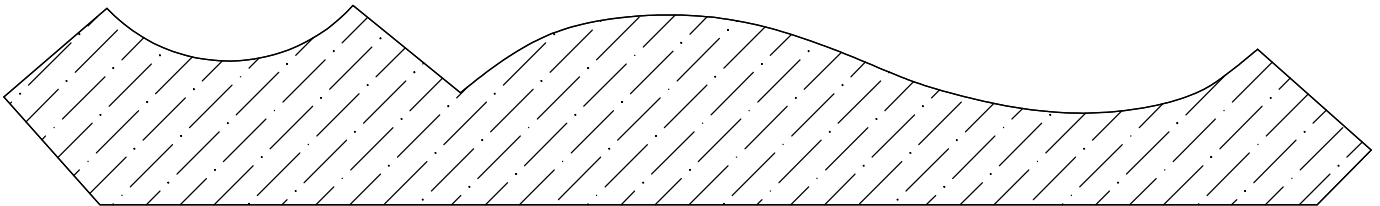

MP11-06 1-1/16 x 7-1/8

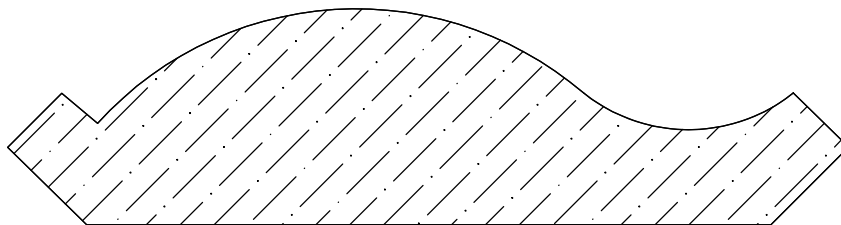

MP11-03 1-1/8 x 4-3/8

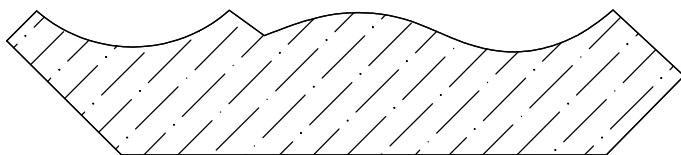

MP11-04 3/4 x 3-9/16

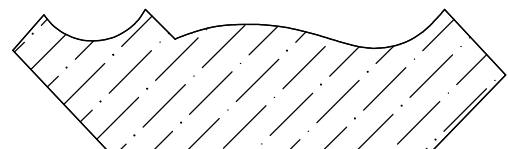

MP11-07 3/4 x 2-9/16



CROWN (cont.)

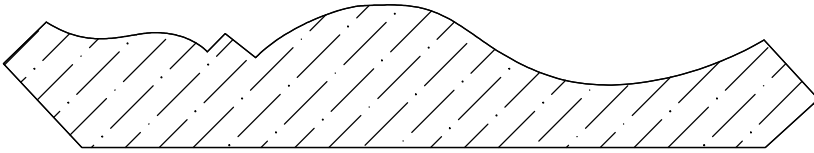

MP11-09 3/4 x 4-1/4

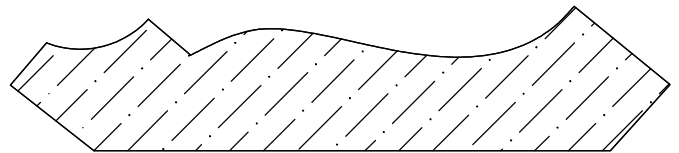

MP11-12 11/16 x 3-7/16

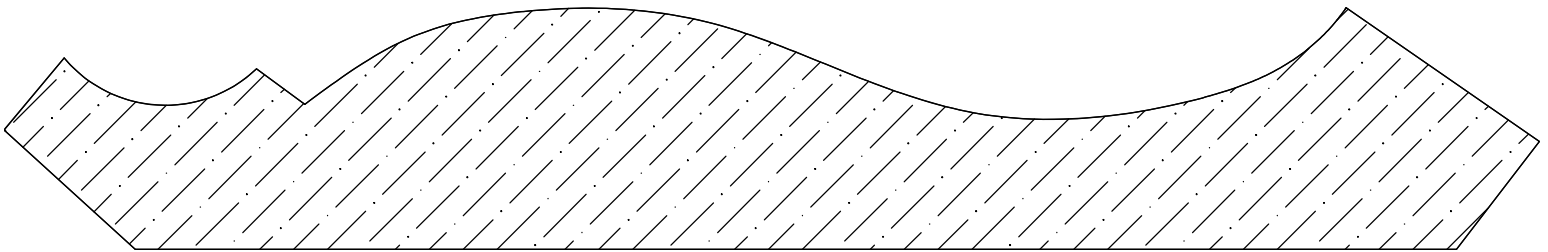

MP11-10 1-1/4 x 8

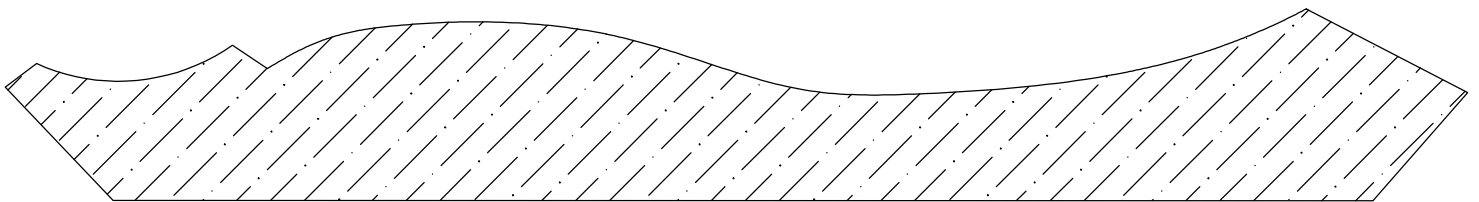

MP11-11 1 x 7-5/8

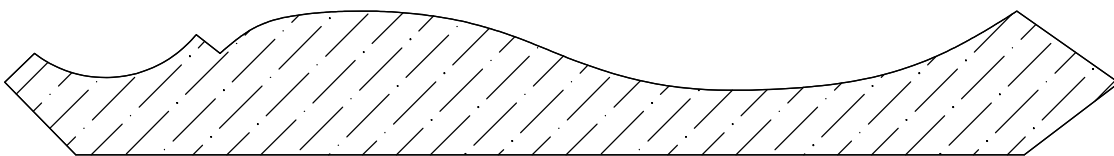

MP11-13 3/4 x 5-13/16

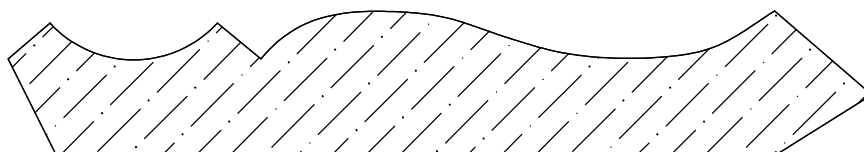

MP11-14 3/4 x 4-1/2



CROWN (cont.)

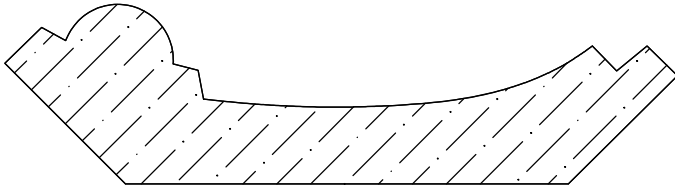

MP11-15
15/16 x 3-1/2

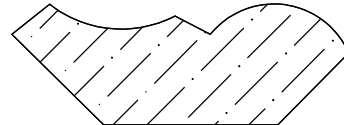

MP11-16
5/8 x 1-3/4

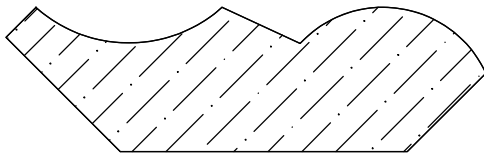

MP11-17
3/4 x 2-1/2

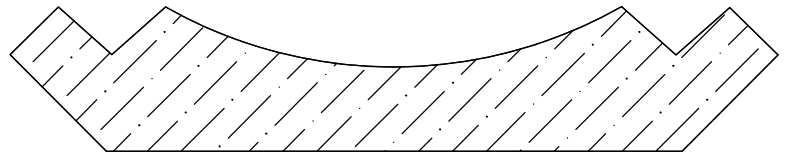

MP11-19
13/16 x 4

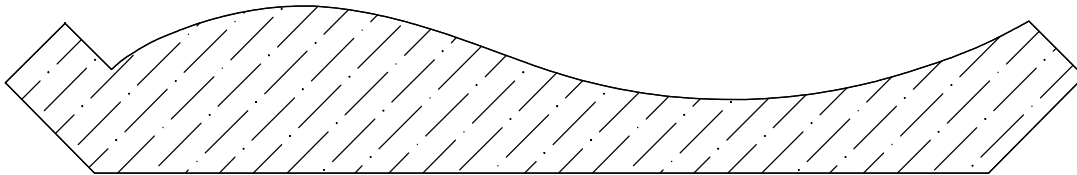

MP11-20 7/8 x 5-5/8

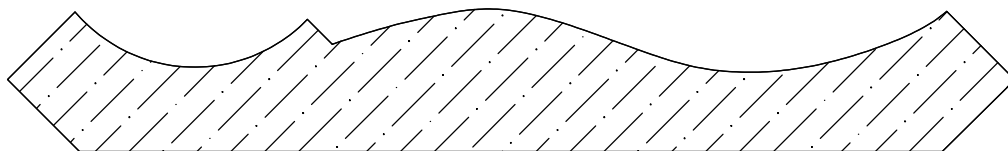

MP11-22 3/4 x 5-1/4

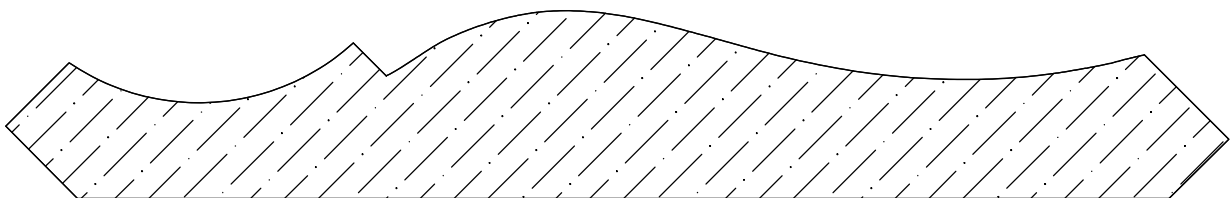

MP11-23 1 x 6-3/8



CROWN (cont.)

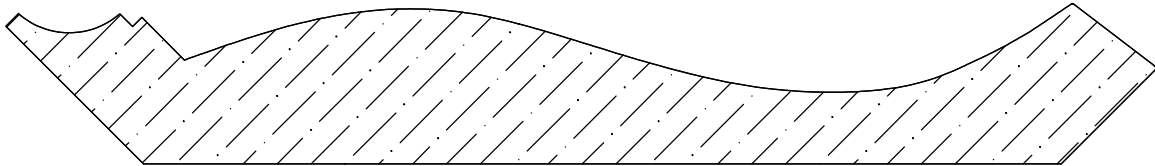

MP11-24 13/16 x 6

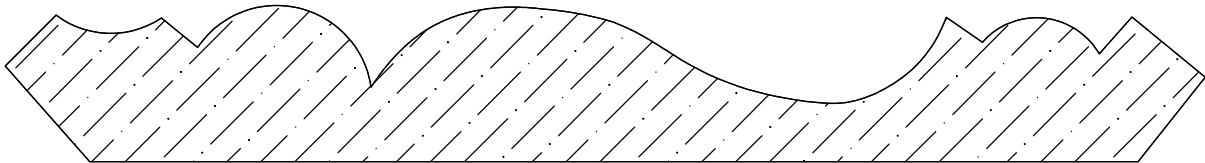

MP11-25 13/16 x 6-1/4

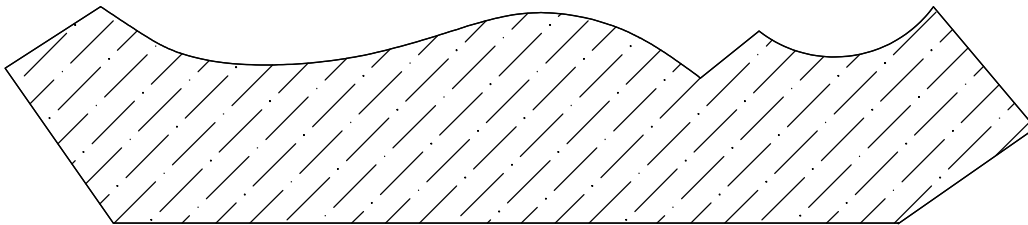

MP11-27 1-1/8 x 5-3/8

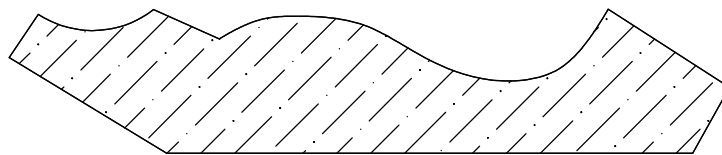

MP11-28 3/4 x 3-3/4

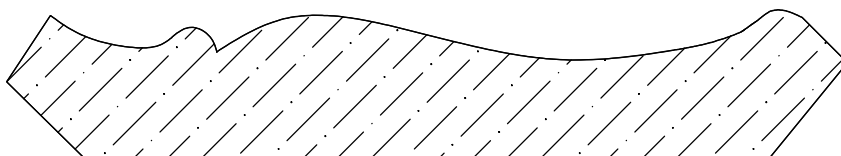

MP11-29 25/32 x 4-3/8



CROWN (cont.)

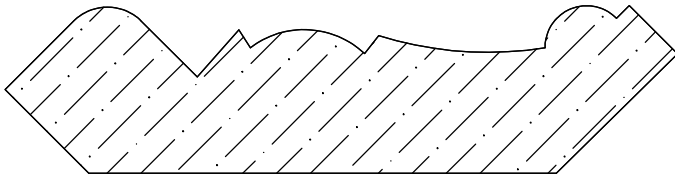

MP11-30
7/8 x 3-1/2

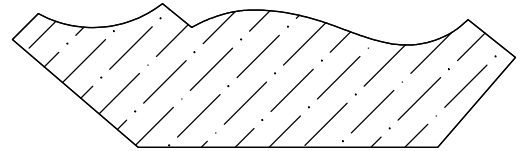

MP11-31
3/4 x 2-5/8

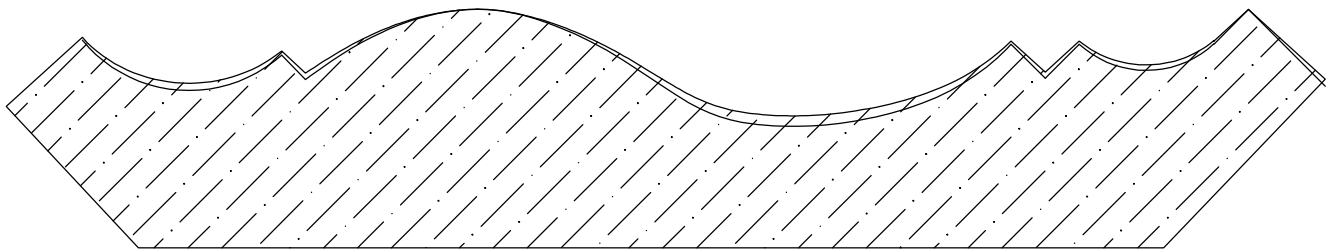

MP11-32 1-1/4 x 6-7/8

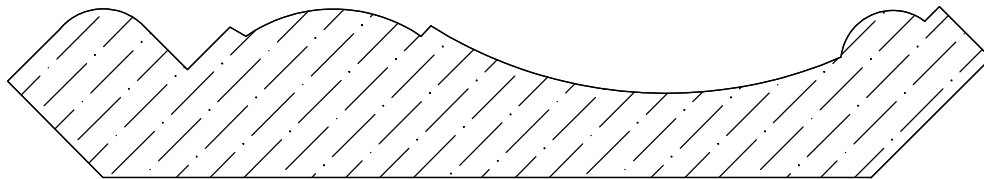

MP11-33 7/8 x 5-1/8

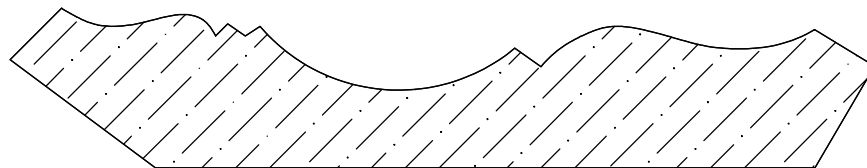

MP11-34 13/16 x 4-1/2

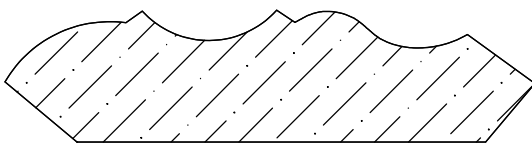

MP11-35
11/16 x 2-3/4

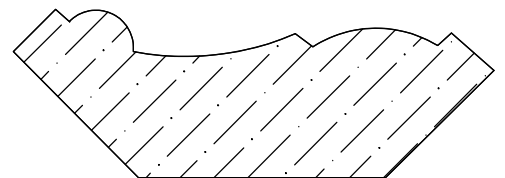

MP11-36
7/8 x 2-1/2



CROWN (cont.)

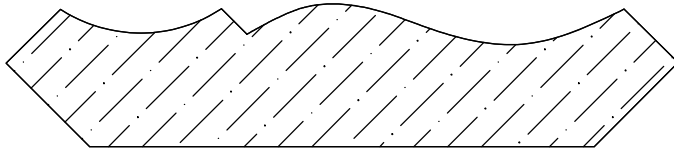

MP11-37
3/4 x 3-1/2

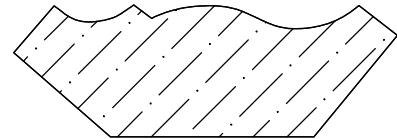

MP11-38
11/16 x 2

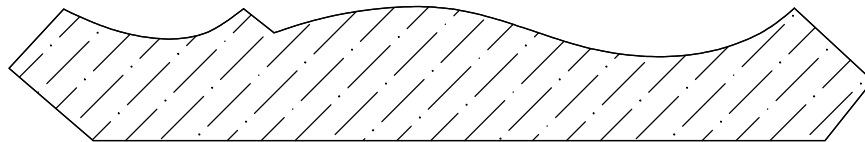

MP11-39 11/16 x 4-1/2

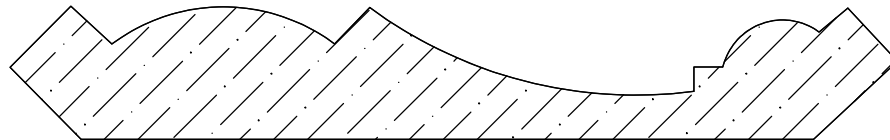

MP11-40 11/16 x 4-5/8

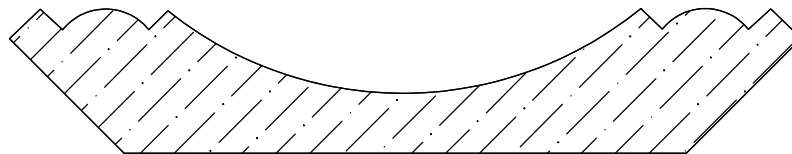

MP11-41 3/4 x 4-1/8

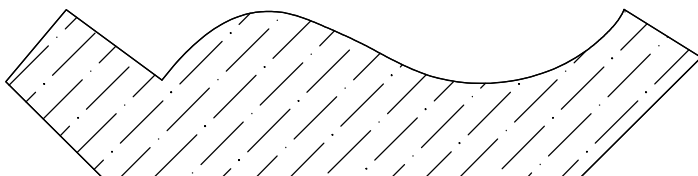

MP11-43
7/8 x 3-5/8

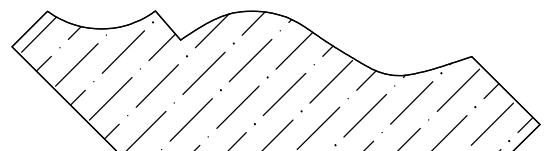

MP11-45
3/4 x 2-3/4



DOOR JAMB

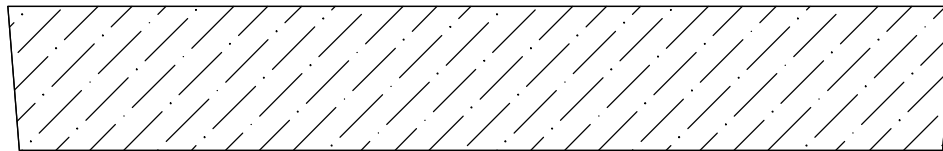
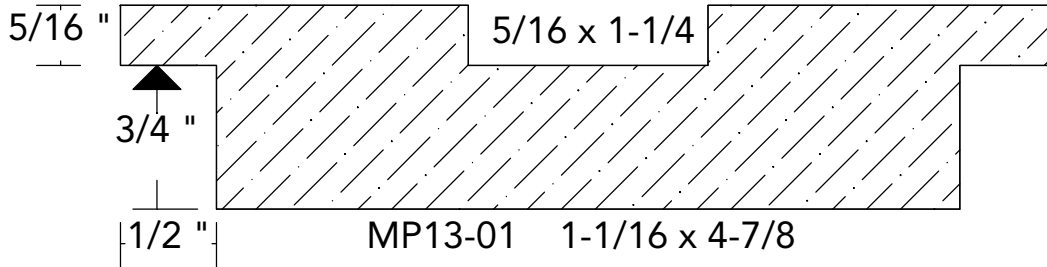

MP13-02 3/4 X 4-7/8
(Other width, thickness, and angle options available)

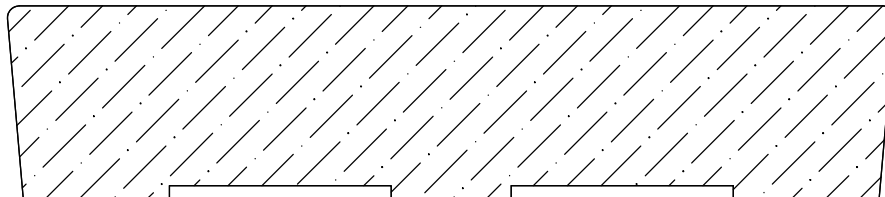

MP13-3 1 x 4-5/8
(Other widths and thicknesses available)

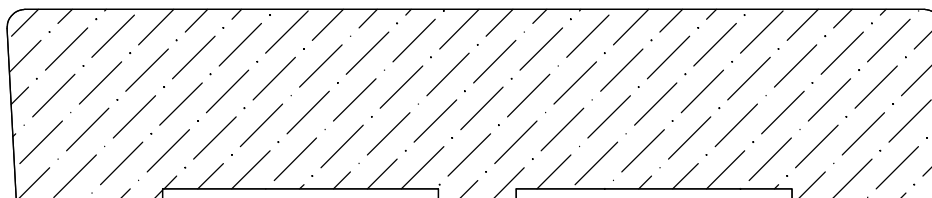

MP13-04 1 x 4-7/8
(Other widths and thicknesses available)



DOOR STILE

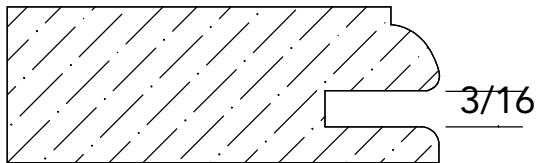

MP29-01
13/16 x 2-1/4

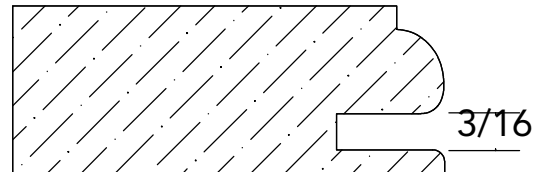

MP29-02
7/8 x 2-1/4

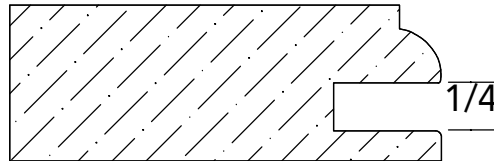

MP29-03
13/16 x 2-1/4

DOOR STOP

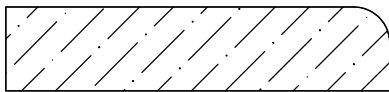

MP12-03
7/16 x 2

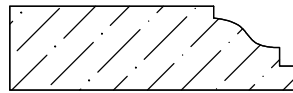

MP12-04
7/16 x 1-1/2

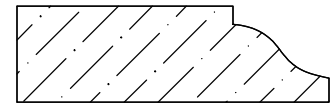

MP12-05
1/2 x 1-5/8

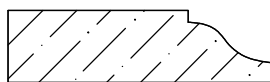

MP12-06
3/8 x 1-3/8

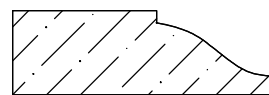

MP12-07
7/16 x 1-3/8



DRAWERSIDES

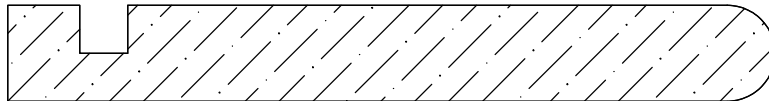

MP14-01 1/2 x 4

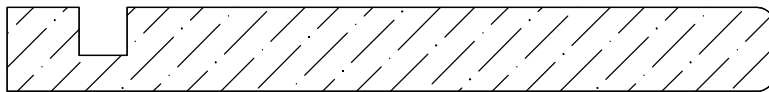

MP14-02 7/16 x 4

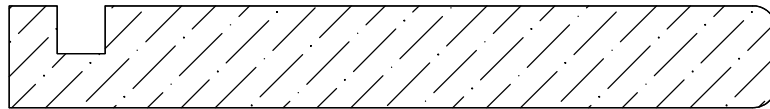

MP14-03 17/32 x 4

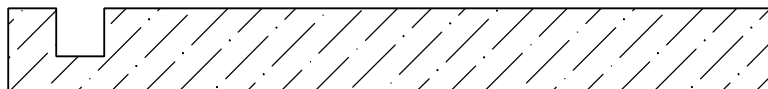

MP14-04 7/16 x 4



FLOORING

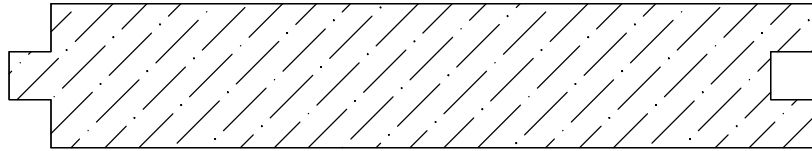

MP19-01 3/4 x 4 face
(Other widths available)

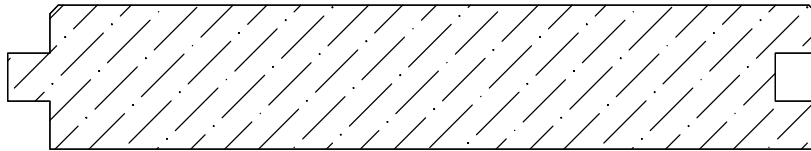

MP19-02 3/4 x 4 face
(Other widths available)

HALF ROUND

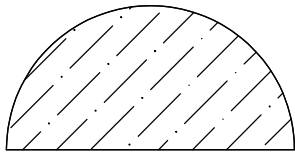

MP22-03
3/4 x 1-1/2

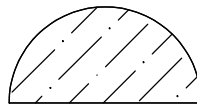

MP22-04
1/2 x 1

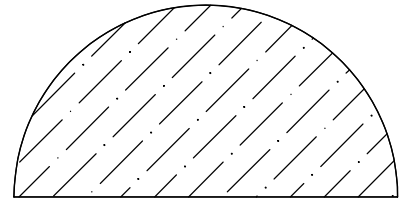

MP22-05
1 x 2

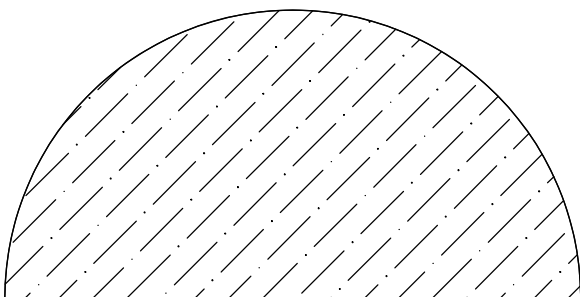

MP22-06
1-1/2 x 3

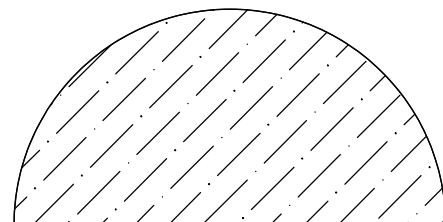

MP22-08
1-1/8 x 2-1/4



HAND RAIL

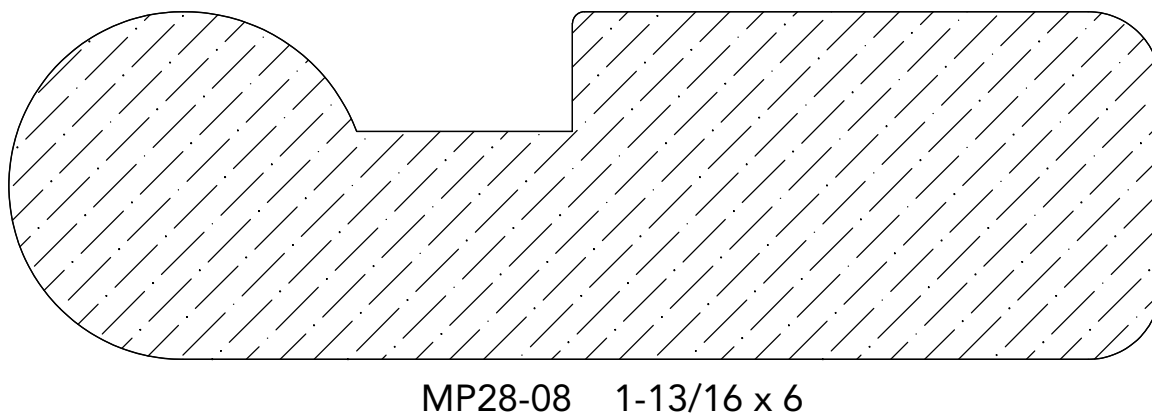
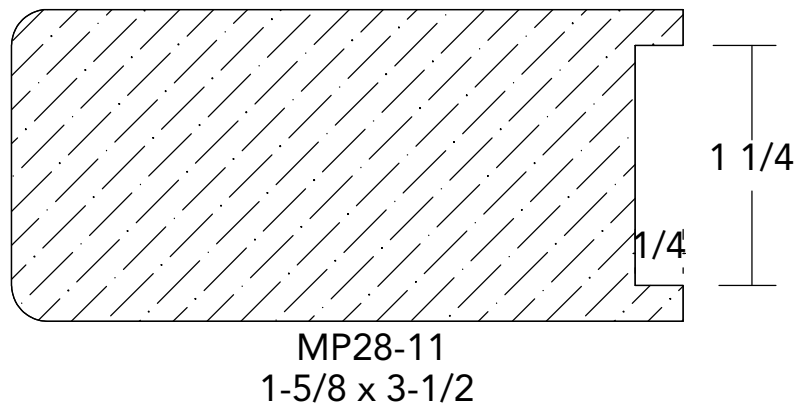
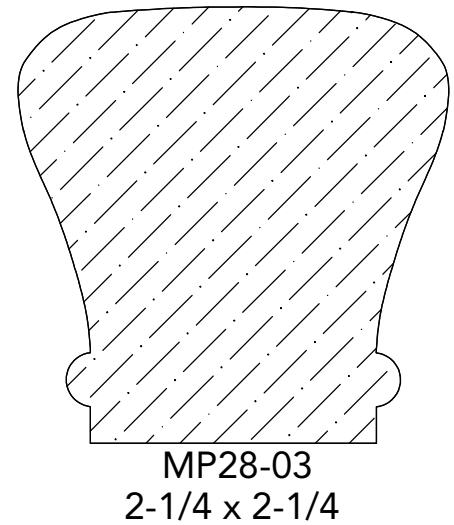
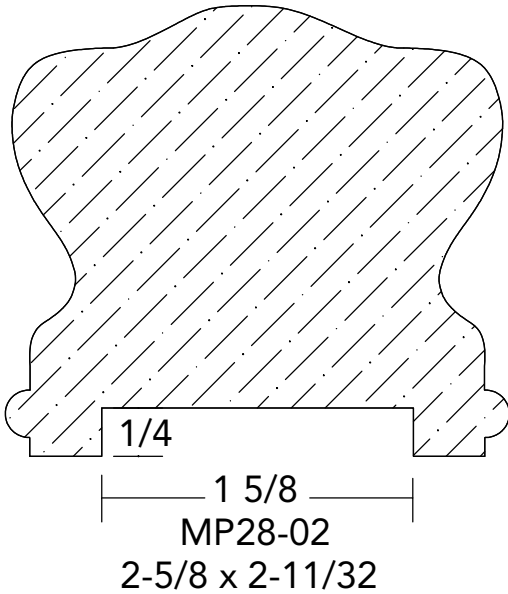



HAND RAIL (cont.)

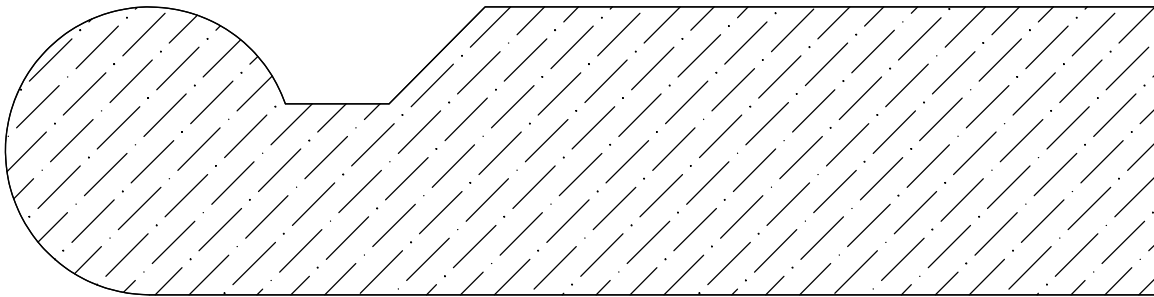

MP28-10 1-1/2 x 6

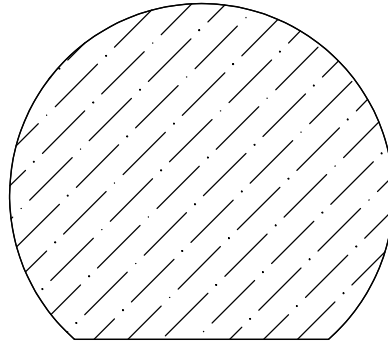

MP28-15
1-3/4 x 2



LANDING TREAD

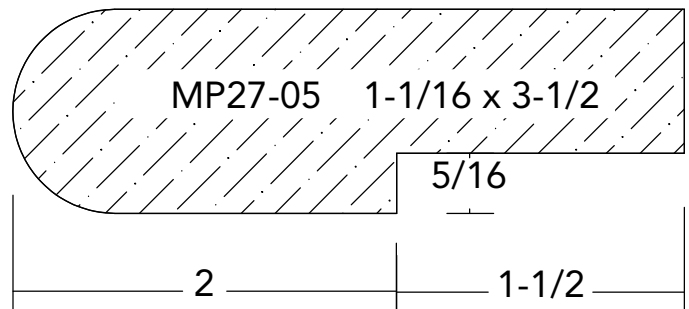
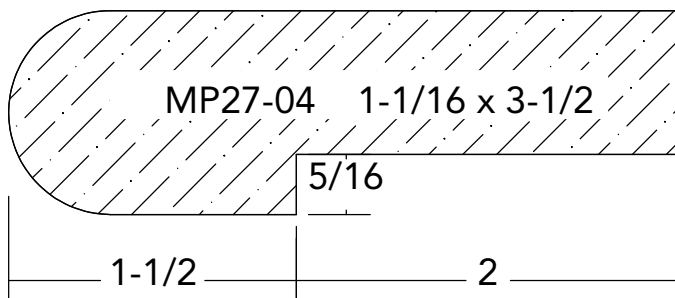
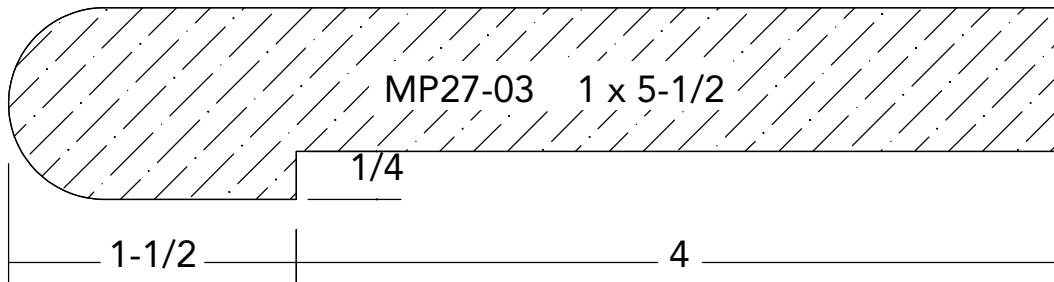
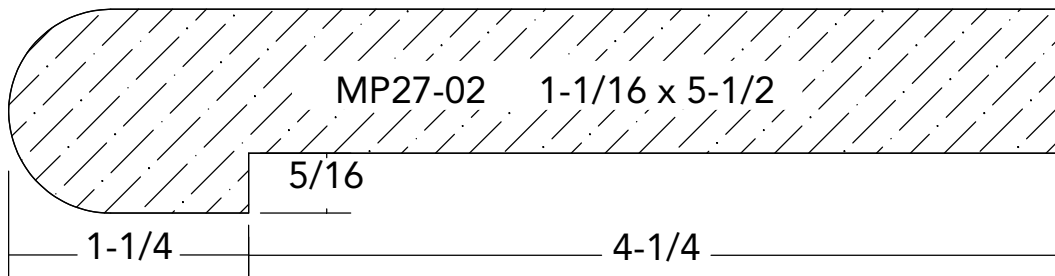
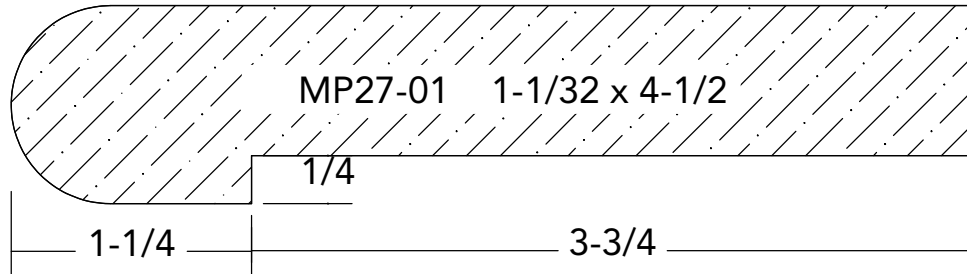



NOSING

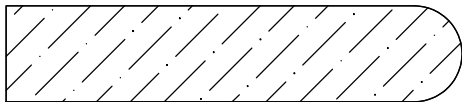

MP20-01
1/2 x 2-3/8
(Other widths available)

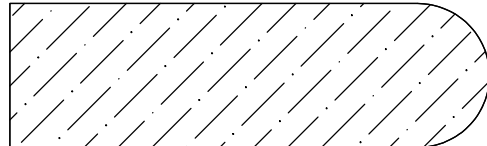

MP20-02
3/4 x 2-1/2
(Other widths available)

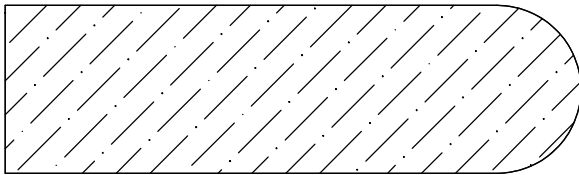

MP20-03
7/8 x 3
(Other widths available)

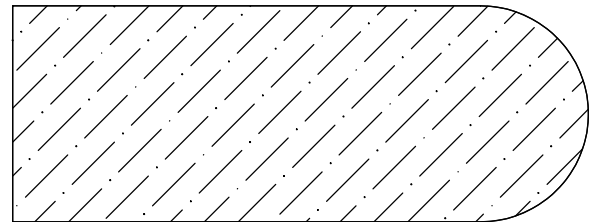

MP20-04
1-1/8 x 3
(Other widths available)

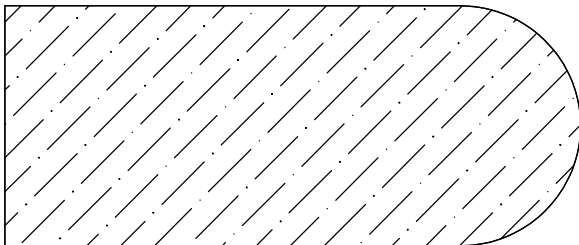

MP20-05
1-1/4 x 3
(Other widths available)

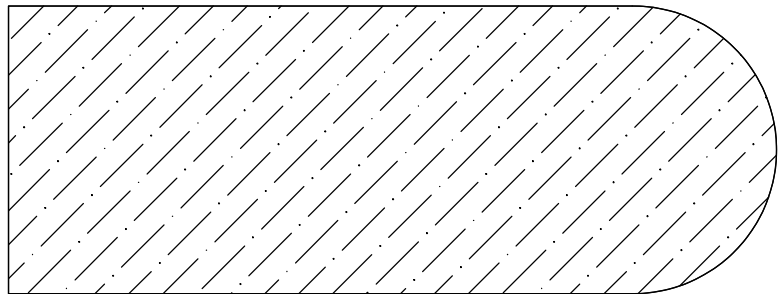

MP20-06
1-1/2 x 4
(Other widths available)



NOSING (cont.)

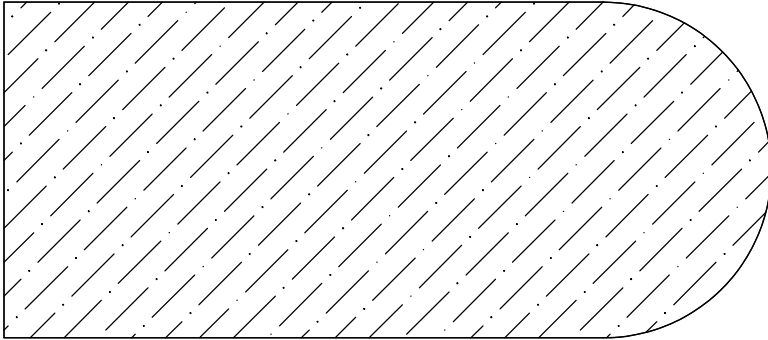

MP20-07
1-3/4 x 4
(Other widths available)

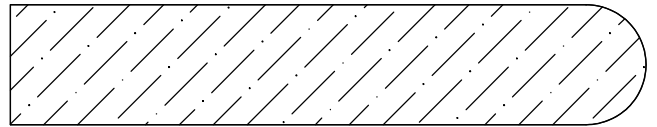

MP20-08
5/8 x 3-5/16
(Other widths available)

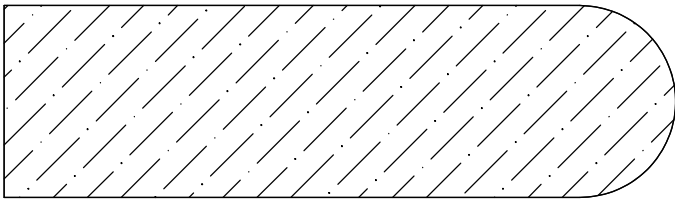

MP20-09
1 x 3-1/2
(Other widths available)

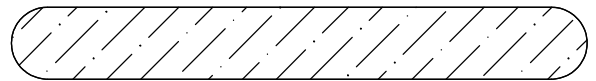

MP20-10
3/8 x 3
(Other widths available)



PANELING

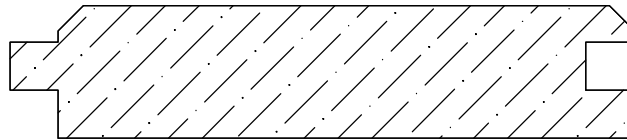

MP21-01

3/4 x 3 (face)

*add 1/4" for overall width
(Other widths available)

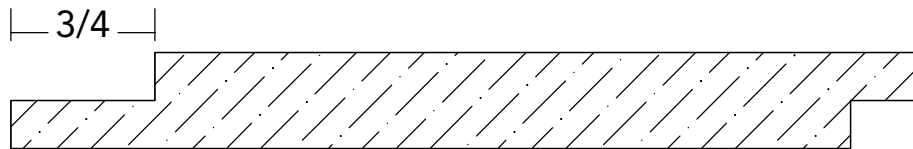

MP21-02

1/2 x 4 face

3/8 face gap after assembly

*add 3/4 for overall width
(Other widths available)

3/8

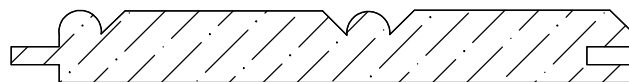

MP21-03

3/8 x 3 face

*add 1/4 to get overall width



PANELING (cont.)

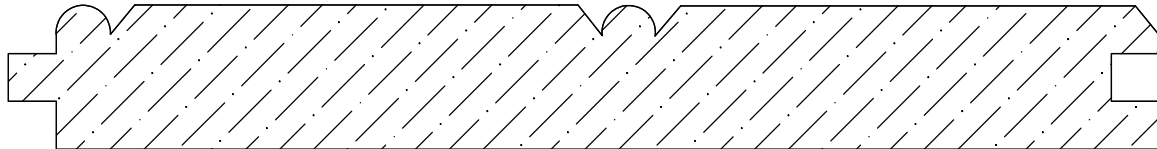

MP21-04 3/4 x 5-3/4 face
*add 1/4 to get overall width

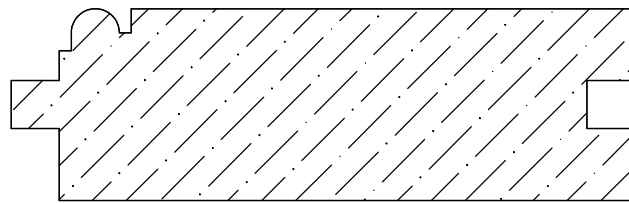

MP21-05 1 x 3 face
*add 1/4 to get overall width

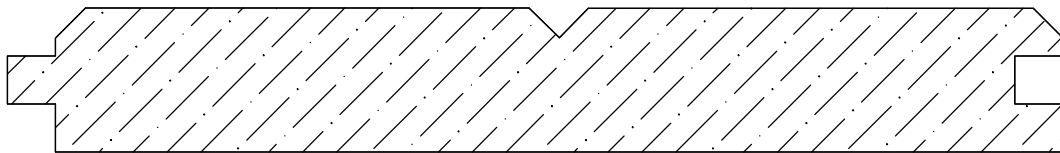

MP21-06 3/4 x 5-1/4 face
*add 1/4 to get overall width

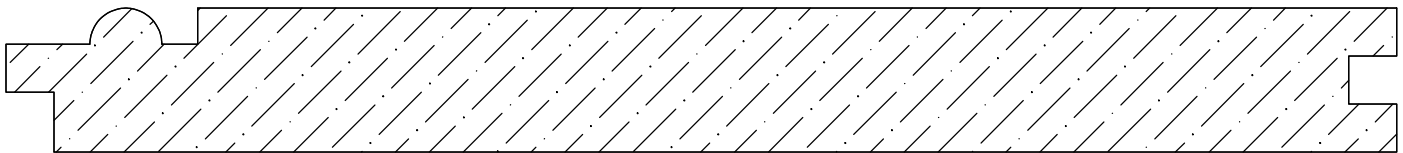

MP21-09 3/4 x 6-3/4 face
*add 1/4 to get overall width



PANELING (cont.)

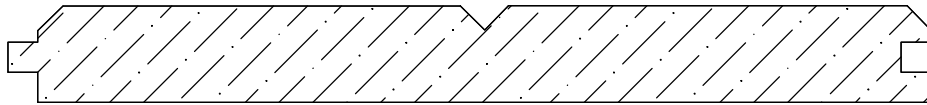

MP21-10 1/2 x 4-13/16 face
*add 5/32 to get overall width

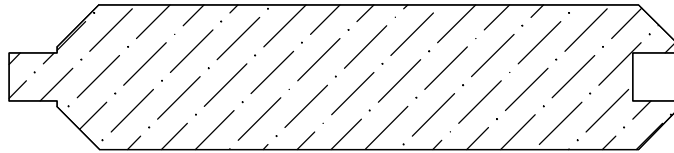

MP21-12 3/4 x 3-1/4 face
*add 1/4 to get overall width
(Other widths available)

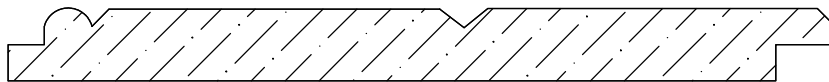

MP21-13 3/8 x 4-1/8 face
*add 3/16 to get overall width

PLATE STOCK

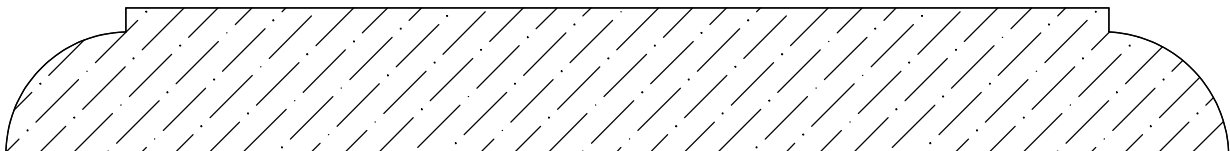

MP24-01 3/4 x 6-3/8
*Other widths available



WAINSCOT CAP

